



# OSAWA & COMPANY PRODUCTS CATALOG

## ● Wonder-Gun is...

a new type of air gun that uses compressed air to blow off, suction, and to transfer materials, and is used widely in many industries.

The products marked  adopt the special jet system, which is a way of bringing out the full power of the compressed air. It works by injecting a large quantity of secondary air in angle to the main air jet and this causes the main air jet to spiral powerfully.

There are no worries that materials get clogged inside of Wonder-gun since it doesn't have any interior restrictions.

## ★ W101 · W301

## Handheld Model

### Three in One (Blow off, Suction, Transferring)!!



Recommended Compressor Power  
**W101.....2.2~3.7kw**  
**W301.....1.1~1.5kw**

Model	Specifications (mm)			
	Length	Minimum ID	Nozzle Orifice	Weight
W101	144	φ22	φ1.4×6holes	310g
W301	142	φ11	φ1.4×3holes	260g

■ We offer powerful version for this model.

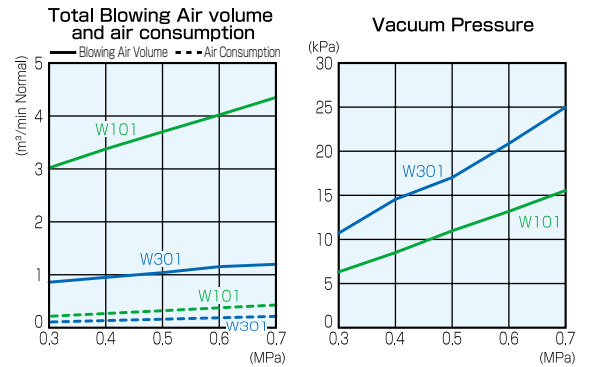

## ● Suction Nozzle Action

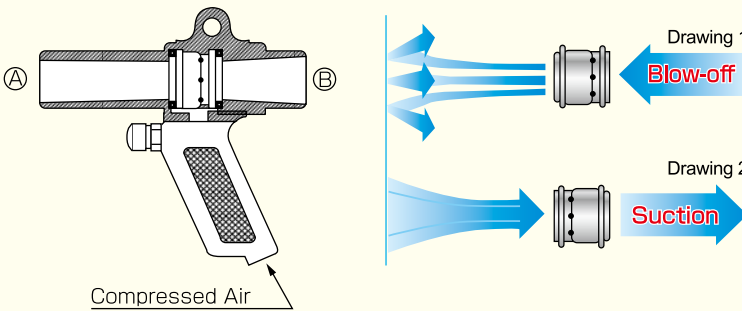

### ■ For Blow-off

Place the suction nozzle as in the left drawing 1. Then start operation. A large amount of air goes into the gun from side (B) together with the compressed air, and a strong air flow is blasted in spirals from the holes on the nozzle.

### ■ For Suction

Place the suction nozzle as in the left drawing 2. Then start operation. A large amount of air goes into the gun from side (A) together with the compressed air, and a strong air flow is blasted in spirals from the nozzle. In this operation, Wonder-gun can be used as a cleaner.

### ■ W101 A set (for suction)

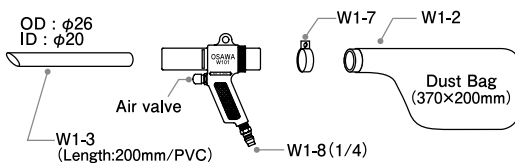

### ■ W101 B set (for suction)

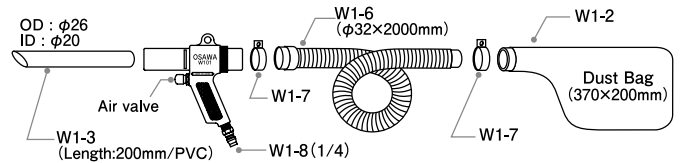

### ■ W301 A set (for suction)

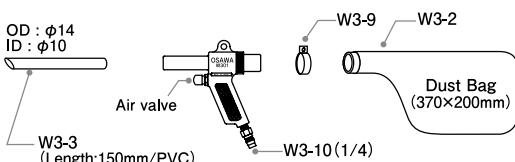

### ■ W301 B set (for suction)

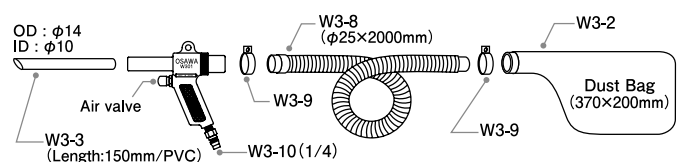

★ W101-III-LC · W101-III-TC · W101-III-LH  
W101-III-TH · W101-III (without hose joint)

## Mounting Model

W101-III-LC



W101-III-TC



W101-III-LH



W101-III-TH



W101-III  
(without hose joint)

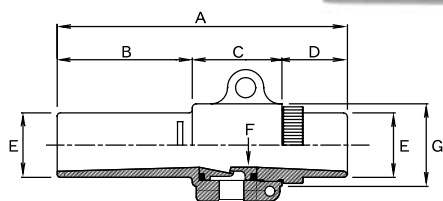

Compressed Air (1/4)

Used Widely in Many Places!!

Model	A	B	C	D	E	F (Min ID)	G	Nozzle Orifice	Weight
W101-III	144	67	44.5	32.5	OD:φ32 ID:φ26	φ22	φ41	φ1.4x6holes	250g

■ Please refer to performance chart on page (1).  
■ We offer powerful versions.

### ■ A set (for suction)

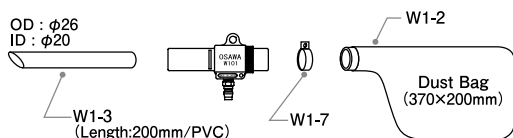

### ■ B set (for suction)

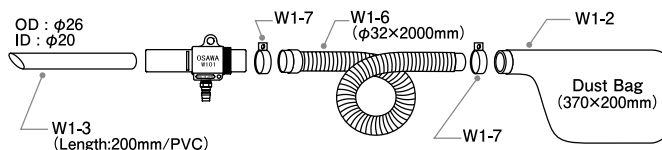

★ W301-III-LC · W301-III-TC · W301-III-LH  
W301-III-TH · W301-III (without hose joint)

## Mounting Model

W301-III-LC

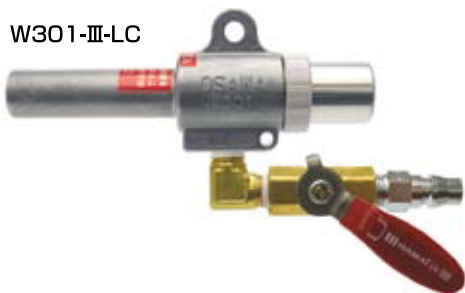

W301-III-TC



W301-III-LH



W301-III-TH



W301-III  
(without hose joint)

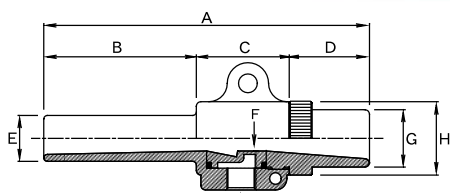

Compressed Air (1/4)

Model	A	B	C	D	E	F (Min ID)	G	H	Nozzle Orifice	Weight
W301-III	142	66.5	40.5	35	OD:φ20 ID:φ14	φ11	OD:φ25 ID:φ18	φ32	φ1.4x3holes	175g

■ Please refer to performance chart on page (1).  
■ We offer powerful versions.

### ■ A set (for suction)

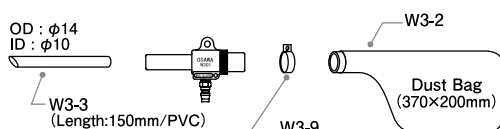

### ■ B set (for suction)

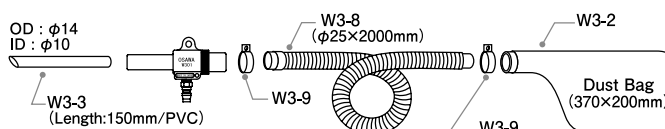

## ★ J-38 · J-50 · J-75 Jumbo Model



**Recommended Compressor Power**  
 J-38...7.5~11kw  
 J-50...15~18.5kw  
 J-75...More than 26kw

**Simple Structure!!  
 Mounting Model !!**

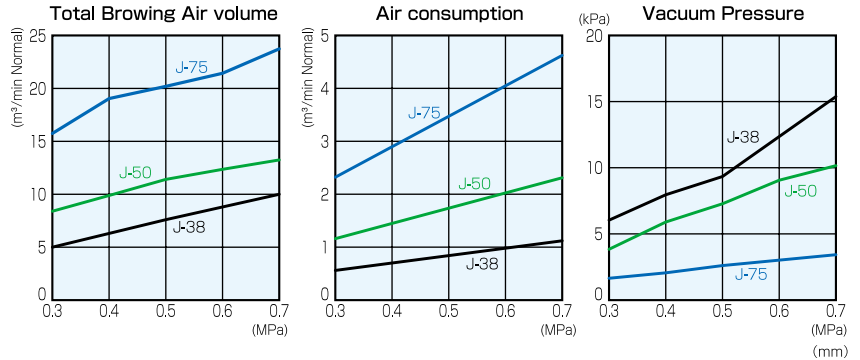
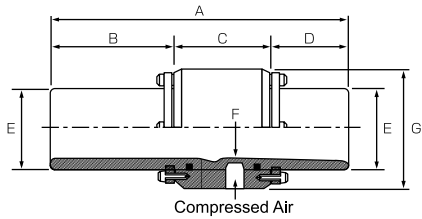

Model	A	B	C	D	E	F(Min ID)	G	Nozzle Orifice	Weight	Ball Valve	Air Connection	Mounting Holes
J-38	190	80	60	50	φ50	φ38	φ 75	φ1.6×12holes	1.8kg	3/8	1/2"	M8×6
J-50	219	90	66	63	φ63	φ50	φ 90	φ2.3×12holes	2.5kg	3/8	1/2"	M8×6
J-75	270	120	76	74	φ90	φ75	φ115	φ2.3×24holes	4.0kg	1/2	3/4"	M8×6

■ Because of small lot of production, Jumbo model becomes out of stock. ■ We offer powerful versions of Jumbo model.  
 ■ We offer hoses and dust bag specially for Jumbo model.

## ★ W501-S · NW501-S · W501-SG · NW501-SG W501-L · NW501-L · W501-LG · NW501-LG Mini Model

**Compact!! Mounting Model !!**

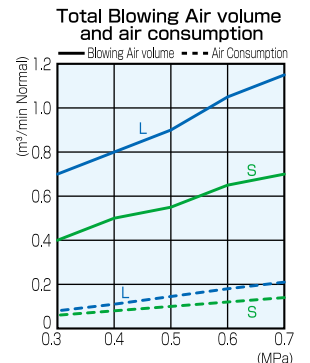
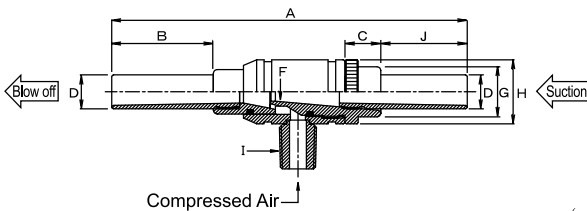
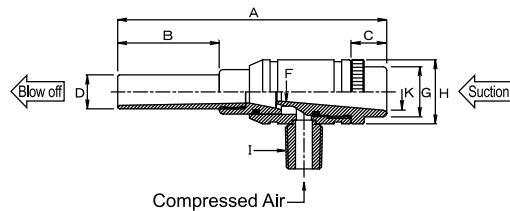
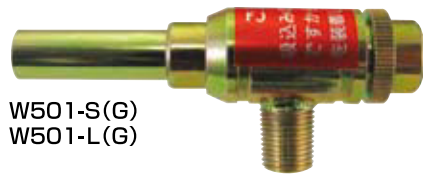

Model	A	B	C	D	F(Min ID)	G	H	I	J	K	Nozzle Orifice	Weight
W501-S(G)	71.5	27	10.5	OD:φ 9 ID:φ 7	φ5	φ13.3	φ17	1/8	—	φ10	φ1.2×3holes(φ1.2×6holes)	58g
W501-L(G)	71.5	27	10.5	OD:φ12 ID:φ10	φ8	φ16.3	φ21	1/8	—	φ13	φ1.3×3holes(φ1.3×6holes)	80g
NW501-S(G)	94.5	27	10.5	OD:φ 9 ID:φ 7	φ5	φ13.3	φ17	1/8	23	—	φ1.2×3holes(φ1.2×6holes)	60g
NW501-L(G)	94.5	27	10.5	OD:φ12 ID:φ10	φ8	φ16.3	φ21	1/8	23	—	φ1.3×3holes(φ1.3×6holes)	83g

■ Powerful versions: Total air blast and thrust increase 70% and suction force increases 50%.

■ B set (for suction)

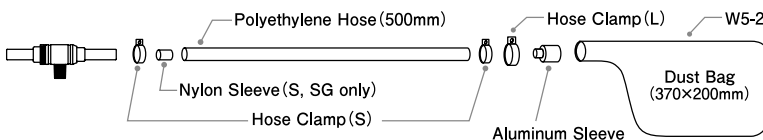

**Recommended Compressor Power**  
 W501-S(L)..... 1.1~1.5kw  
 W501-SG(LG)..... 1.5~3kw  
 NW501-S(L)..... 1.1~1.5kw  
 NW501-SG(LG).... 1.5~3kw

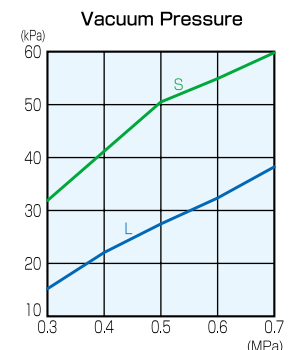

## ★ YW501-SG · YW501-LG YW501 Model

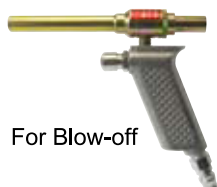

**Recommended Compressor Power**  
 1.5~3kw

YW501 series are equipped with hand-grips. Please make sure to specify either suction or blow-off.

■ Please confirm delivery schedule since YW501 type are custom-ordered products.

## ★ W101-YZ

## Wide-Catch Model

Draws in and Blow off At the Same Time. How Clever!

Plenty of Uses...

- Cleaning inside of wide-mouth bottles!
- Cleaning food containers!
- Removing chips from holes!



W101-YZ

### Features:

Air Blow Nozzle blows off materials and a Wide-mouth suction pipe never fails to catch them.

- \* Wonder-Gun Wide Catch model is provided as the unit below.
- Please order "W101-YZ Gun only" when you require only the gun.
- \* It can be used with Dust Collector PC-1 or W1-20.

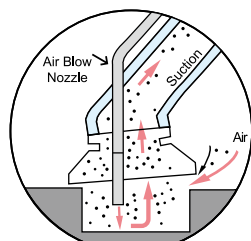

**Don't seal completely!!**  
Requires outside air intake to work effectively.

■ Wonder-Gun Wide Catch model is provided as the unit below.

### Unit contains:

- Wide-Catch Model ————— 1
- $\phi 32$  Duct Hose(2m) ————— 1
- Dust Bag ————— 1
- Hose Clamp ————— 2

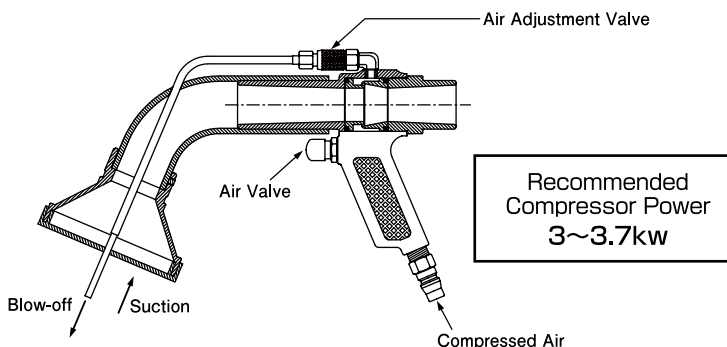

Recommended Compressor Power  
3~3.7kw

Model	Specifications					
	Length	Weight	Wide-mouth metal fitting	Air Blow Nozzle OD	Suction Nozzle ID	Nozzle Orifice
W101-YZ	281	600g	OD: $\phi 98$ ID: $\phi 85$	$\phi 4$	$\phi 22$	$\phi 1.4 \times 6$ holes

### ■ Unit contains

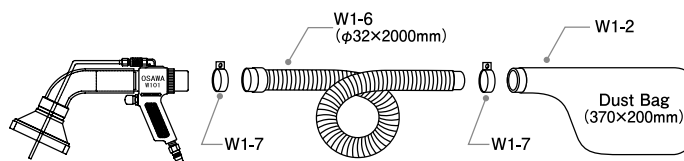

## ★ W101-YZ-LC · W101-YZ-TC · W101-YZ-LH W101-YZ-TH · W101-YZ (without hose joint)

## Mounting Model



W101-YZ-LC



W101-YZ-TC



W101-YZ-LH

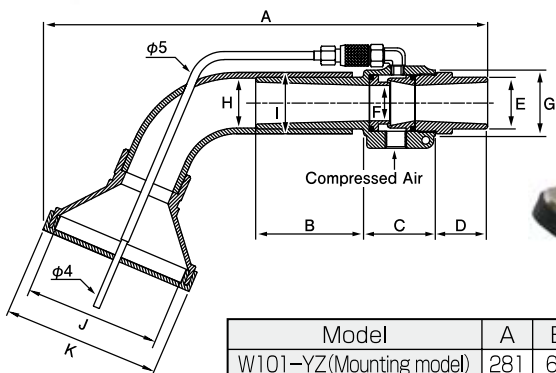

W101-YZ-TH



W101-YZ (without hose joint)

Model	A	B	C	D	E	F (Min ID)	G	H	I	J	K	Nozzle Orifice
W101-YZ (Mounting model)	281	67	44.5	32.5	OD: $\phi 32$ ID: $\phi 26$	$\phi 22$	$\phi 41$	$\phi 31$	$\phi 39$	$\phi 85$	$\phi 98$	$\phi 1.4 \times 6$ holes

### ■ A set

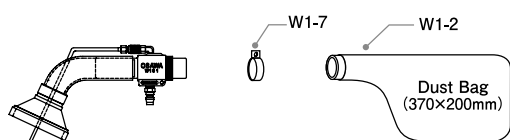

### ■ B set

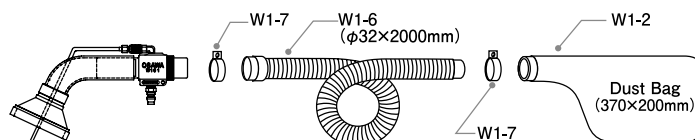

Wide-Catch Mounting Model is not a set; If you wish, please specify A or B at the end of the model number.

## ☆ W101-II Hole Cleaning model



W101-II

● Wonder-Gun Hole Cleaning model can be used with Dust Collector PC-1 or W1-20.

### How It Works:

Put Air Blow Nozzle into a hole and then press Air Valve. Air comes out from the nozzle, and blow dust off. The dust is cleaned by the Transparent pipe.

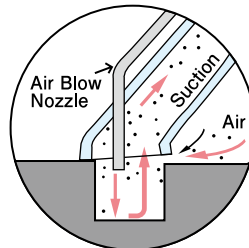
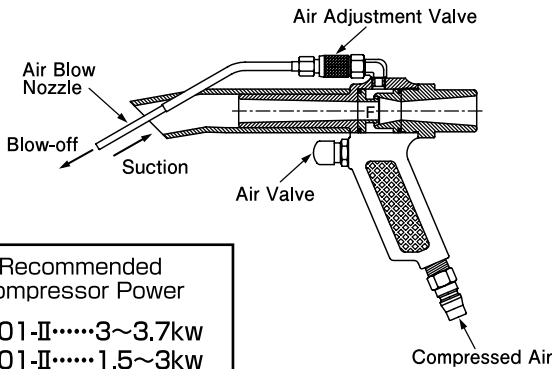

**Don't seal completely!!**  
Requires outside air intake to work effectively.

Recommended Compressor Power  
W101-II.....3~3.7kw  
W301-II.....1.5~3kw

Model	Specification (mm)					
	Length	Weight	Suction Pipe	Air Blow Nozzle OD	Suction Nozzle Min ID(F)	Nozzle Orifice
W101-II	235	435g	OD:φ39 ID:φ31	φ5	φ22	φ1.4×6穴
W101-II	210	350g	OD:φ26 ID:φ20	φ4	φ11	φ1.4×3穴

## ☆ W301-II Hole Cleaning model



W301-II

● Wonder-Gun Hole Cleaning model can be used with Dust Collector PC-3 or W3-20.

■ Wonder-Gun Hole Cleaning model is provided as the unit below.

### Unit contains:

- Hole Cleaning Model ——— 1
- Duct Hose(2m) ——— 1
- Dust Bag ——— 1
- Hose Clamp ——— 2

- Cleans dust or chips in holes efficiently!!
- Demonstrates great power in tapping!!

### Unit contains

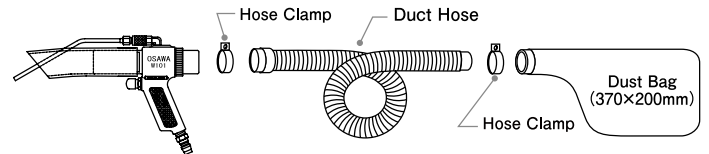

## ☆ W101-II-LC · W101-II-TC · W101-II-LH W101-II-TH · W101-II(without hose joint) Hole Cleaning Mounting model

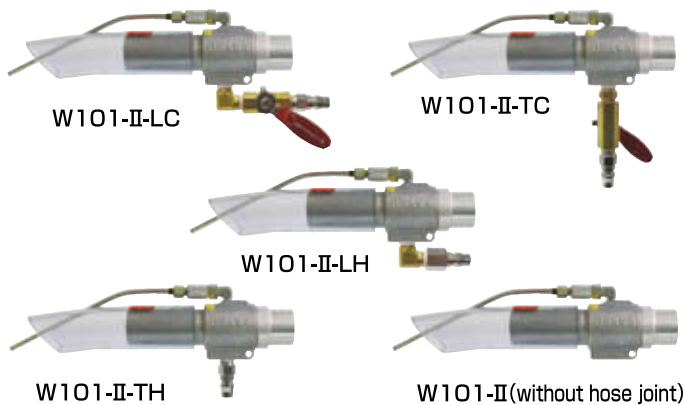

## ☆ W301-II-LC · W301-II-TC · W301-II-LH W301-II-TH · W301-II(without hose joint) Hole Cleaning Mounting model

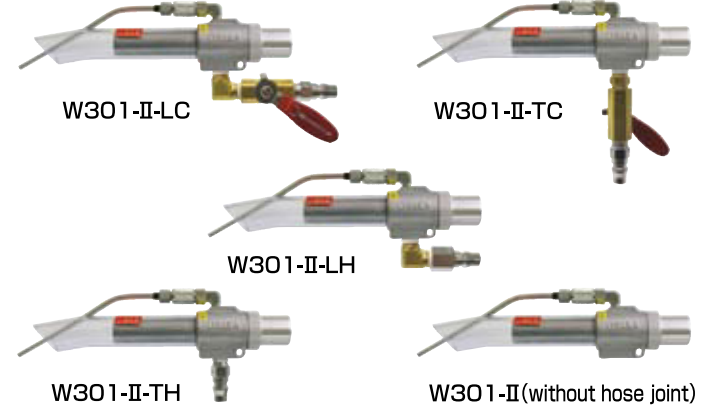

### A set

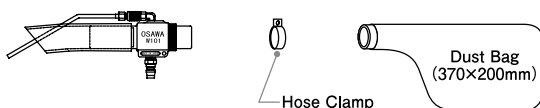

### B set

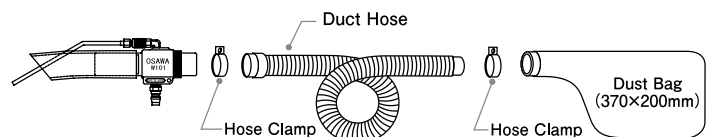

Hole Cleaning Mounting model is not a set; If you wish, please specify A or B at the end of the model number.

## ★ W701

## Pencil Model



**Small Size!!**  
**Use as tweezers or for**  
**Cleaning in corners!!**

### Feature

1. Compact and fits in your hand.
2. Can be used with low-pressure compressed air (0.15~0.5MPa), thus safe and doesn't need much compressed air.
3. Suction pipe can be easily replaced for other uses.
4. There are no worries that materials will get clogged inside of Wonder-Gun due to a smooth walled interior construction.

Recommended Compressor Power  
**0.75kw**

■ W701 pencil model is provided as the unit below.

### Unit contains:

- Pencil Model \_\_\_\_\_ 1
- 6×4 Air Tube 1.4m \_\_\_\_\_ 1  
(Equipped with 1/4" hose joint)
- 8×5 Tube for dust bag 0.4m \_\_\_\_\_ 1
- Injection needle nozzle \_\_\_\_\_ 1
- Dust Bag for W701 \_\_\_\_\_ 5

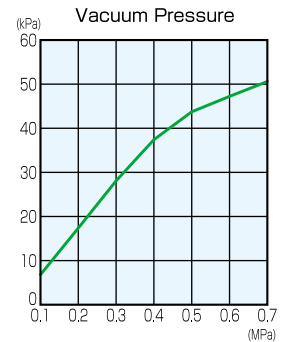

Specification (mm)			
Length	ID	OD	weight
137	φ2.8	φ20	60g

## FV-10

## Air Foot Valve



**For Easy Pedal Operation!!**

- 1 Strong Enough for Daily Use.  
This product is made of aluminum die casting.
- 2 Easy Operation.  
Use both hands free; Can be used with foot.
- 3 Simple Construction.  
Air passes through smoothly so there are no breakdowns.

Length	Width	Height	Weight	Hose Joint
170	82	58	480g	1/4"

Air Foot Valve can be connected to W101 and W301 mounting model, W501 series, W701, and other air tools as well.

## W301-ES-22 · W301-ES-26

## Air Blast Model

Easily remove rust, scale and paint from parts and small equipment, leaving a satin finish ready for paint or further preparation. Air blast type sprays most abrasives including glass beads, aluminum oxide, steel grit, or liquids like oil. Draws abrasives straight from bucket or bag.

■ W301-ES-22 Weight 406g SK Jet Nozzle ID φ6

Air Pressure MPa	Discharge per minute		Vacuum Pressure kPa	Air Consumption ℓ/min Normal
	Sand	Water		
0.4	800g	1000cc	57.6	234
0.5	850g	800cc	55.3	280
0.6	850g	700cc	49.7	327
0.7	850g	550cc	41.8	373

■ W301-ES-26 Weight 440g SK Jet Nozzle ID φ8

Air Pressure MPa	Discharge per minute		Vacuum Pressure kPa	Air Consumption ℓ/min Normal
	Sand	Water		
0.4	1800g	1800cc	56.5	462
0.5	1800g	1650cc	58.4	554
0.6	2000g	1500cc	57.5	646
0.7	2000g	1400cc	53.8	738

■ We offer a powerful version of air blast gun (W301-ES-28 with Jet Nozzle ID φ10). Please contact us for detail.

■ W301-ES air blast model is provided as the unit below.

Recommended Compressor Power

W301-ES-22.....1.5~3kw  
 W301-ES-26.....3~5.5kw

### Unit contains:

- Air Blast Model \_\_\_\_\_ 1
- Suction Hose (2m) \_\_\_\_\_ 1
- Suction Pipe (Iron) \_\_\_\_\_ 1

**Powerful Injection!!**

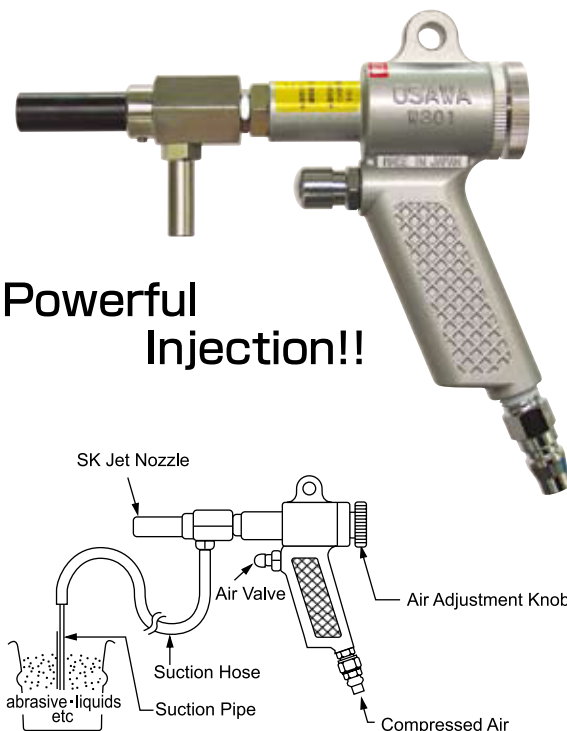

※ This can be remodeled to mounting model. Please refer to mounting model on page (2).



W1-20 · W1-20SET  
W3-20 · W3-20SET

Dust Collector  
Dust Collector Set



Dust Collector  
W1-20 (Weight : 6.7kg)

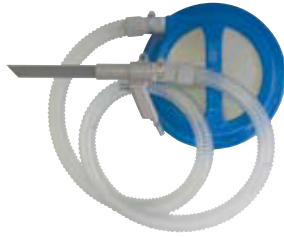

Dust Collector Set  
W1-20SET (Weight : 7.7kg)



Dust Collector  
W3-20 (Weight : 6.7kg)



Dust Collector Set  
W3-20SET (Weight : 7.4kg)

Unit Contains:

Model	Wonder-Gun	Suction Pipe	Hose(Oil Resistance)	Hose Clamp	Dust Collector	Air coupler
W1-20 Set	W101 1PC	φ20×200mm 1PC	φ32×2000mm 1PC	2PCS	W1-20(φ300) 1PC	1/4 1PC
W3-20 Set	W301 1PC	φ10×150mm 1PC	φ25×2000mm 1PC	2PCS	W3-20(φ300) 1PC	1/4 1PC

※The above products don't include any tanks.

## Easy to Use!! For a Wide Range of Application!

- W1-20 set and W3-20set series can be combined with 20ℓ tank. You can collect the materials which have been vacuumed by Wonder-Gun.
- W1-20 can be combined with Wonder-Gun W101 series mounting model, Wide-Catch model, and Hole Cleaning model.
- W3-20 can be combined with Wonder-Gun W301 series mounting model, and Hole Cleaning model.
- We offer replacement filters.

Wonder-Gun Dust Collector series don't fit to handle liquid and powders. Please use Silent Cleaner or Mini Porter Cyclone for liquids and powders.

■Please refer to page(1) for performance chart.



PC-1 · PCS-1  
PC-3 · PCS-3

Dust Filter  
Dust Collector Super



Dust Filter  
PC-1 (Weight : 6.5kg)



Dust Collector Super  
PCS-1 (Weight : 7.7kg)



Dust Filter  
PC-3 (Weight : 6.5kg)



Dust Collector Super  
PCS-3 (Weight : 7.4kg)

Unit Contains:

Model	Wonder-Gun	Suction Pipe	Hose(Oil Resistance)	Hose Clamp	Dust Collector	Air coupler
PCS-1	W101 1PC	φ20×400mm 1PC	φ32×2000mm 1PC	2PCS	PC-1	1/4 1PC
PCS-3	W301 1PC	φ10×300mm 1PC	φ25×2000mm 1PC	2PCS	PC-3	1/4 1PC

## Easy to Move!! For a Wide Range of Application!

- Equipped with a 20ℓ tank and aluminum stand with casters. Easy to move.
- PCS-1 can be combined with Wonder-Gun W101 series mounting model, Wide-Catch model, and Hole Cleaning model.
- PCS-3 can be combined with Wonder-Gun W301 series mounting model, and Hole Cleaning model.
- We offer replacement filters.

Wonder-Gun Dust Collector series don't fit to handle liquids and powders. Please use Silent Cleaner or Mini Porter Cyclone for liquids and powders.

■Please refer to page(1) for performance chart.



★ SC60-32S · SC60-38S (for Dust Collection)  
 SC60-32S W/F · SC60-38S W/F (for Fine Dust Collection)

## POWERFUL & SILENT

Silent Cleaner can handle water, oil, sludge, gravel, grain, metal chips and many more materials than other existing vacuum cleaners

★Removable!!  
 ★Built-in Silencer!!

★Use for Hours of Continuous Operations!!



●For fine powder, please use cleaners for fine dust collection.

### ■ Performance Chart(SC60-32S(W/F) · SC60-38S(W/F))

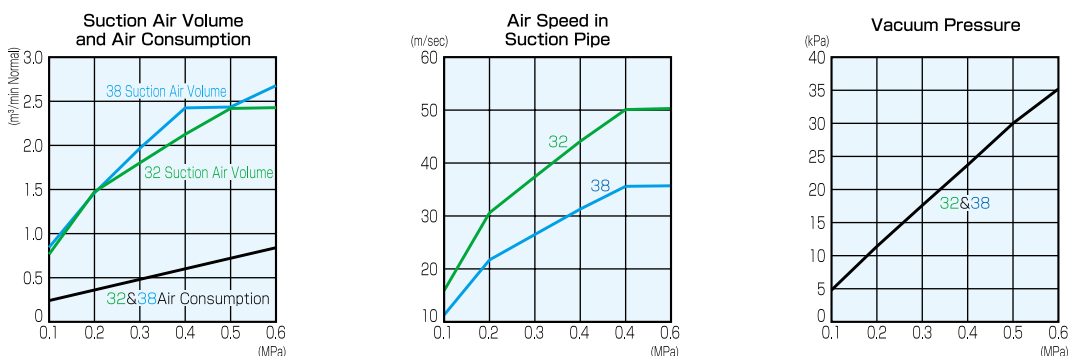

Recommended Compressor Power  
 5.5~7.5kw

# SILENT-CLEANER®

★ SC30-32S (for Dust Collection)  
 SC30-32S W/F (for Fine Dust Collection)

## ● Jet Ejector

Jet Ejector, the heart of the Silent Cleaner, is the device that creates strong suction. There are no rotating parts so no breakdowns.

## ● Silencer

The silencer keeps exhaust sound low - 60dB with SC30-32S.

## ● Safety Valve

Safety valve prevents sudden increase of vacuum and breakage of tank, which is caused by air pressure rise or hose obstruction.

## ● Inner Filter

Inside of Silencer, is glass-wool-made filter. This filter prevents dust from going outside. Please order "fine dust filter" for fine dust.

### For Dust Collection;

One filter made of glass wool is equipped. It can be used to collect liquids and solids.

### For Fine Dust Collection;

It becomes a double filter of glass wool filter and cloth cover. It can be used for powders recovery.



● For fine powder, please use cleaners for fine dust collection.

■ Performance Chart (SC30-32S(W/F), SC20-32(W/F), SC20-32P(W/F))

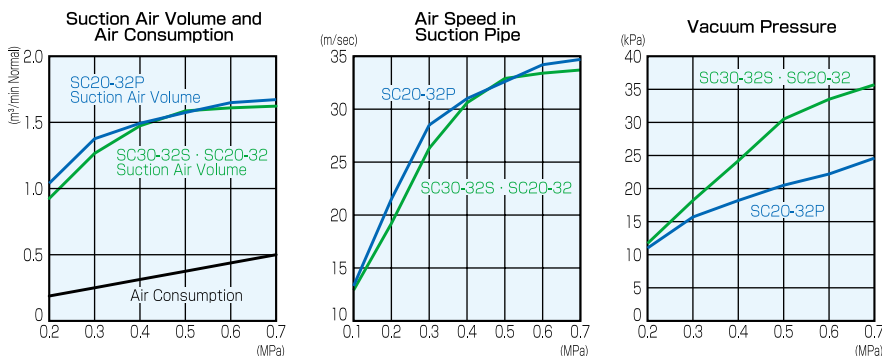

Recommended Compressor Power  
 2.2~3.7kw

★ SC20-32 (for Dust Collection)  
 SC20-32 W/F (for Fine Dust Collection)



● For fine powder, please use cleaners for fine dust collection.

## Easy to Use... Put it on a Tank!!

★ SC20-32P (for Dust Collection)  
 SC20-32P W/F (for Fine Dust Collection)

(For 20ℓ Tank)

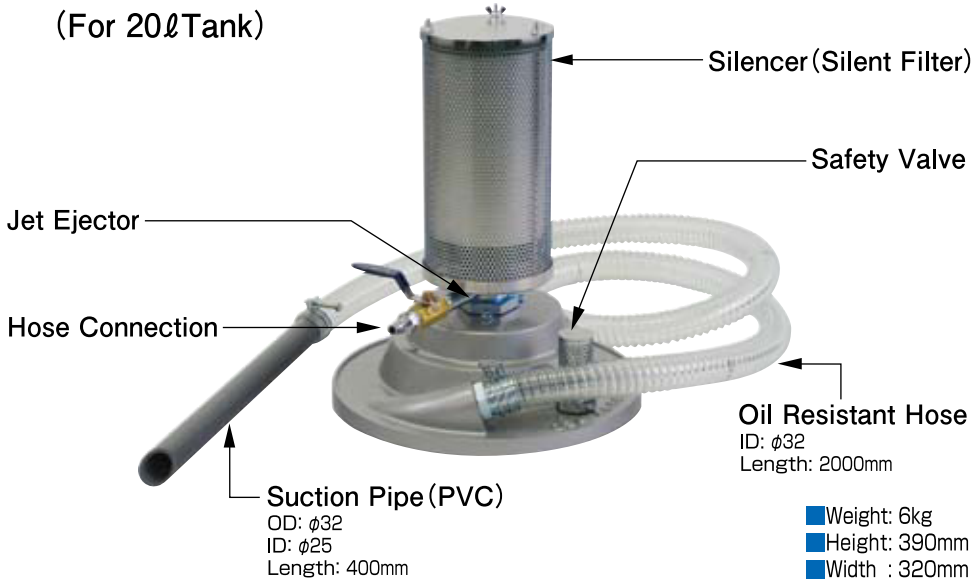

- Please put SC20-32P(W/F) on a 20ℓ Tank. For performance, please refer to performance chart on page(9).
- For fine powder, please use cleaners for fine dust collection.

★ SC200-32D (for Dust Collection) · SC200-38D (for Dust Collection)  
 SC200-32D W/F (for Fine Dust Collection) · SC200-38D W/F (for Fine Dust Collection)

(For 200ℓ Open Drum)

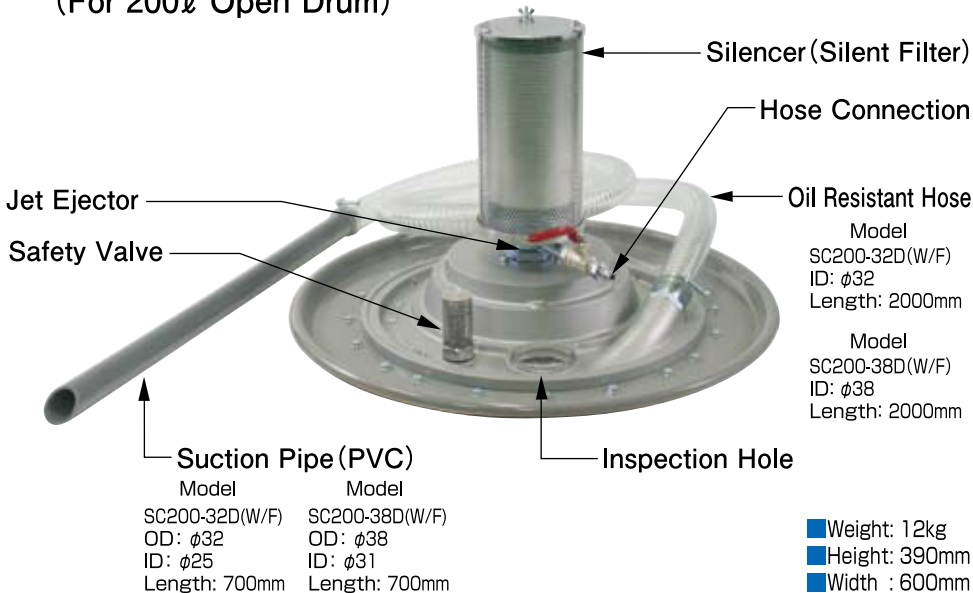

- Please put SC200-32D(W/F) or SC200-38D(W/F) on a 200ℓ open drum. For performance, please refer to performance chart on page(8).
- For fine powder, please use cleaners for fine dust collection.

- We offer powerful versions of Silent Cleaner; ex: SC20-32PG, SC200-32DG.
- We offer Silent Cleaner for fine dust collection.

SC60-38SW/F	SC60-32SW/F	SC30-32SW/F	SC200-32DW/F
SC20-32W/F	SC20-32PW/F	SC60-50SW/F	SC200-38DW/F

- We recommend attaching Mini Porter Cyclone for a large amount of fine dust or powder.
- We offer Conductive Hose or Antistatic Hose.

### ■ Accessories (sold separately)

Fine Dust Filter Cloth Cover



● Fine Dust Filter Set

Please use Fine Filter for fine powder.



● Hydro Stopper

Hydro Stopper stops suction automatically when Silent Cleaner ingests certain amount of liquid.



● Floor Brush



● Round Dusting Brush



● Narrow Nozzle

# SILENT-CLEANER®

★ SC60-50S (for Dust Collection)  
 SC60-50S W/F (for Fine Dust Collection)

**More POWERFUL  
 than other models of  
 Silent Cleaner!!**

**Powerful!! and SILENT!!**

Cleans water, oil, sludge, grains, gravels and metal chips that other existing vacuum cleaners cannot. Recommended for any work place!

★ Built-in Silencer!

★ Two-Ejectors System !

★ Use For hours of operation!



● For fine powder, please use cleaners for fine dust collection.

## ■ Performance Chart(SC60-50S(W/F))

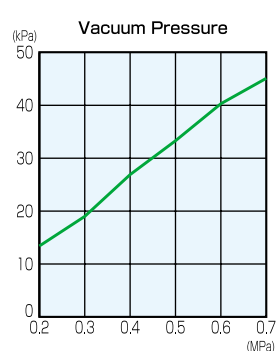
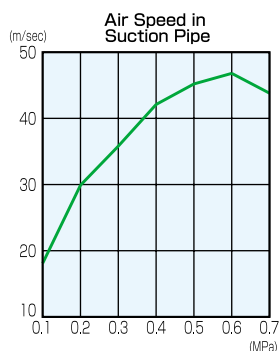
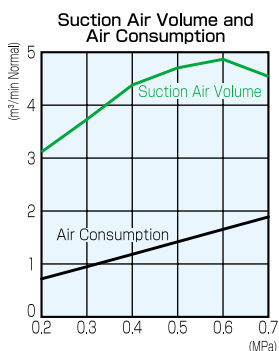

Recommended  
 Compressor Power  
 11~15kw

## ☆ SC30-32TVG (for High Viscosity liquid)

**Vacuum Thick Materials  
such as Mayonaise and  
Grease EASILY !!**

### Powered by Compressor!!

No Rotating Parts -  
Breakdowns Caused by Wear and Tear Are  
Minimized !!

### Grease Model -for High Viscosity liquid

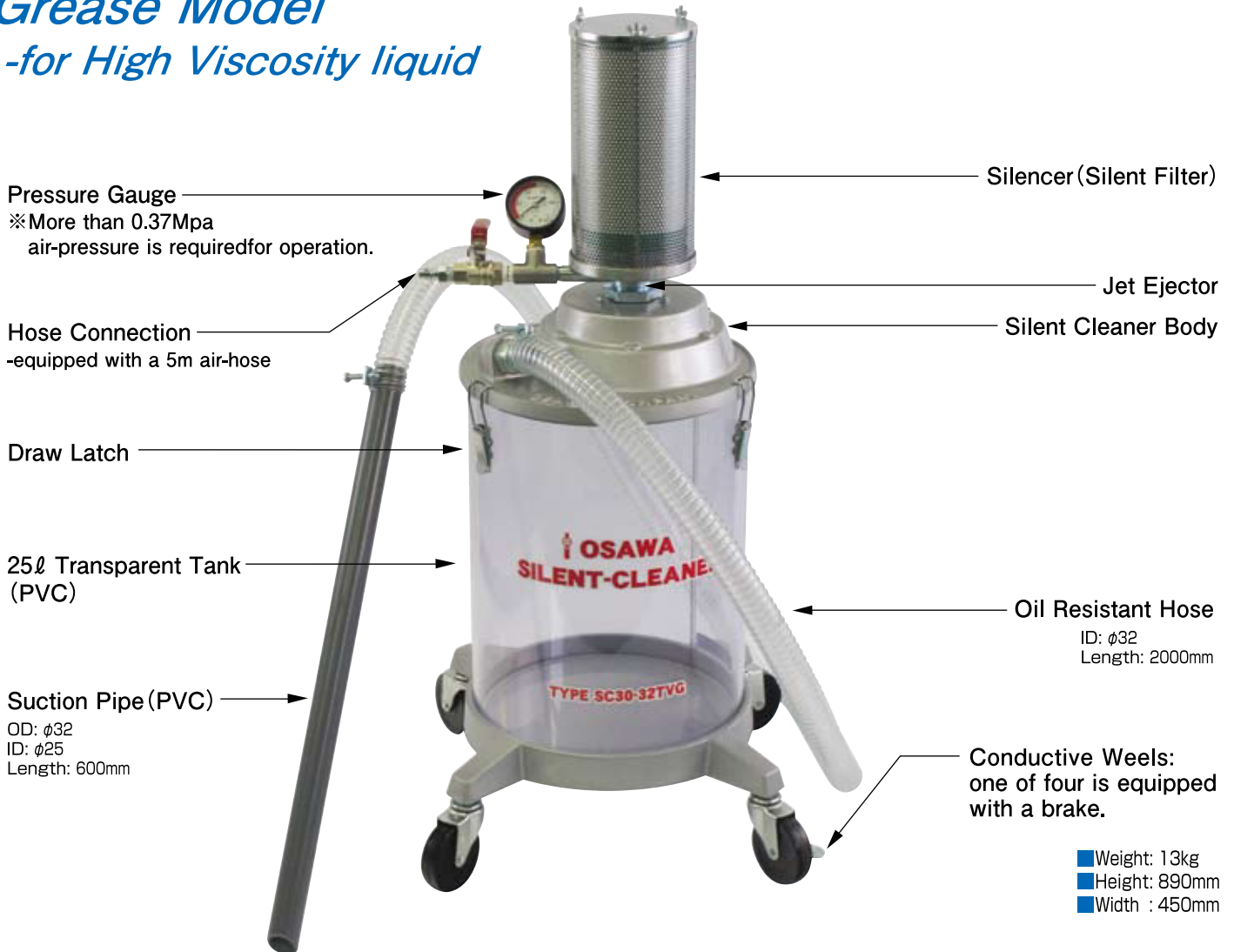

### ■ Performance Chart (SC30-32TVG · SC3T-19VG)

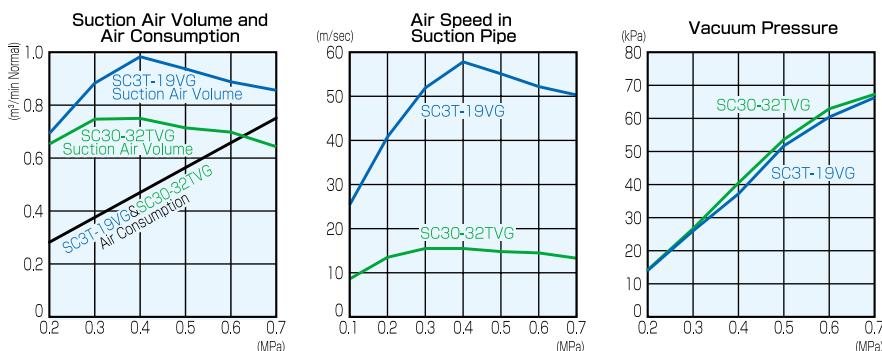

Recommended Compressor Power More than 5.5kw

### ☆ SC3T-19VG (for High Viscosity liquid)



# MINI-PORTER-CYCLONE®

## MP-38 CF12

No Filters are used to process fine dust or powder.

Can be connected to Any Vacuum Cleaner!!  
Easy to Move!!

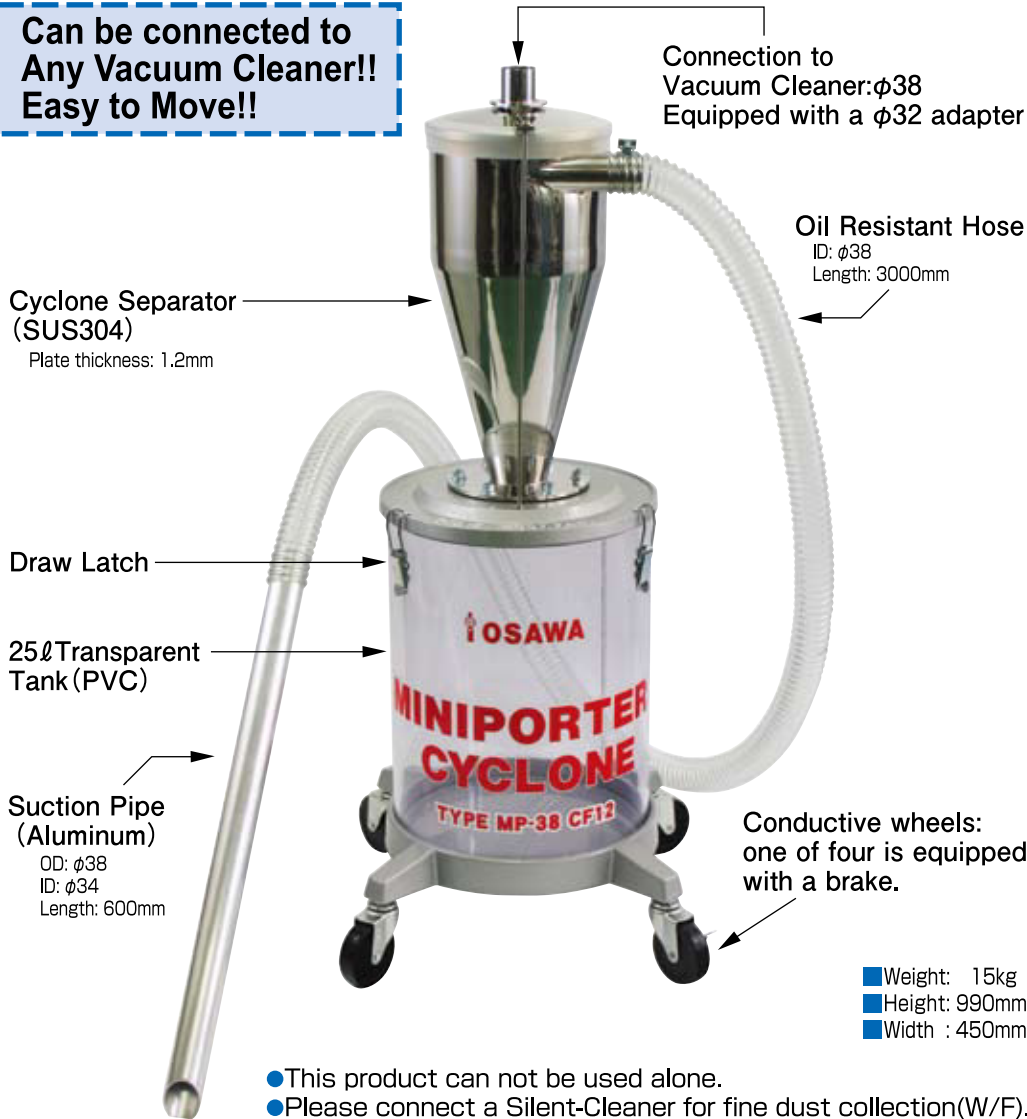

### Centrifugal Action of Mini Porter Cyclone

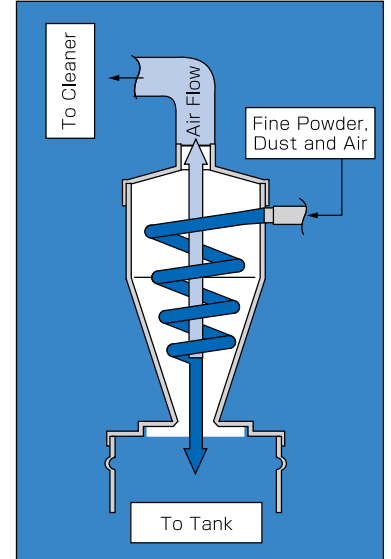

## TROUBLES IN HANDLING FINE POWDER??

Mini Porter Cyclone separates powder and air by centrifugal force and sheer dead weight with no filters. Eventually, the powder is dropped into a tank and accumulates while the air flows into the suction machine. When handling flour, for example, the efficiency is almost 100%. This function reduces maintenance and helps to save expense and time.

- Weight: 15kg
- Height: 990mm
- Width : 450mm

- This product can not be used alone.
- Please connect a Silent-Cleaner for fine dust collection(W/F).

## LIGHT AND COMPACT!!

Great for Cleaning Office Automation Equipment Dust, Toner and stuff.

### MP-19

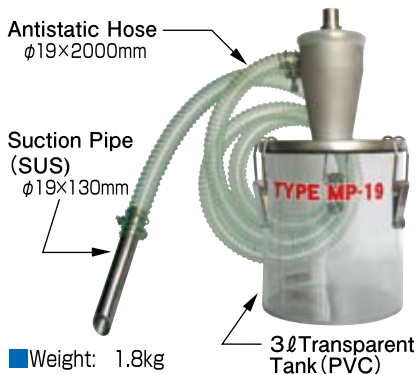

- Weight: 1.8kg
- Height: 335mm
- Width : 160mm

- MP-19 can not be used alone.
- Please connect a SC3T-19.

### ★ SC3T-19

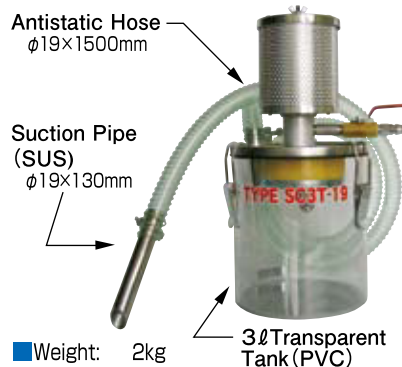

- Weight: 2kg
- Height: 340mm
- Width : 160mm

### Example of Combination



- MP-19: The smallest in the Mini Porter series.
- SC3T-19: The smallest in the Silent Cleaner series
- Please contact us for further details.

## ★ Combination Model

**Easy to Move!!**  
**Great for**  
**Fine Powder!!**



● For performance, please refer to performance chart on page(9).

## ★ MP-38WA CF12 with Ejector

**Built-in**  
**Jet Ejector!!**

MP-38WA series are designed specially to handle fine powder.

**No Filters** are used to process fine dust or powder.

**No Rotating parts** - Breakdowns caused by wear and tear are minimized.  
 (Same construction as Silent Cleaner)

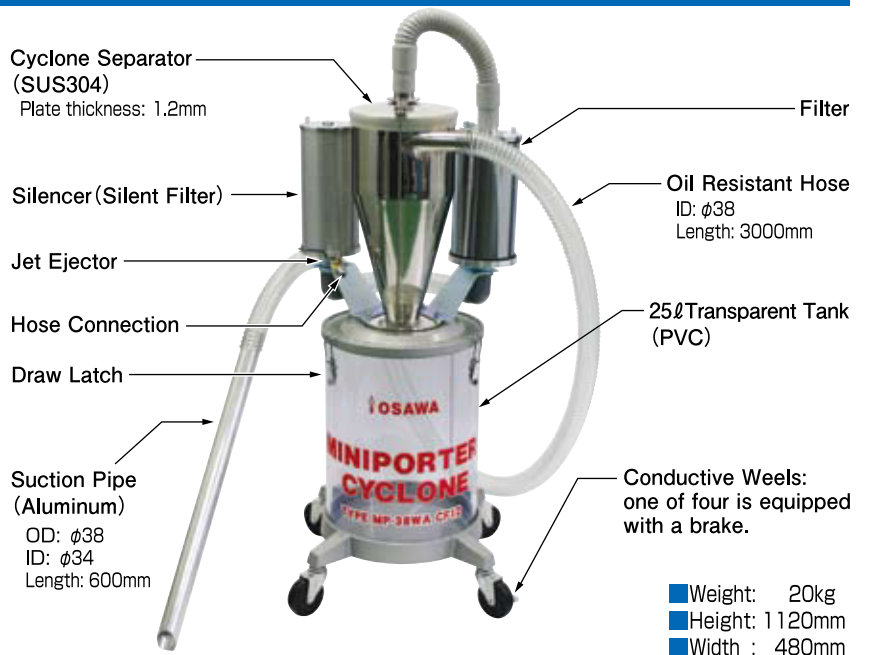

### ■ Performance Chart(MP-38WA CF12)

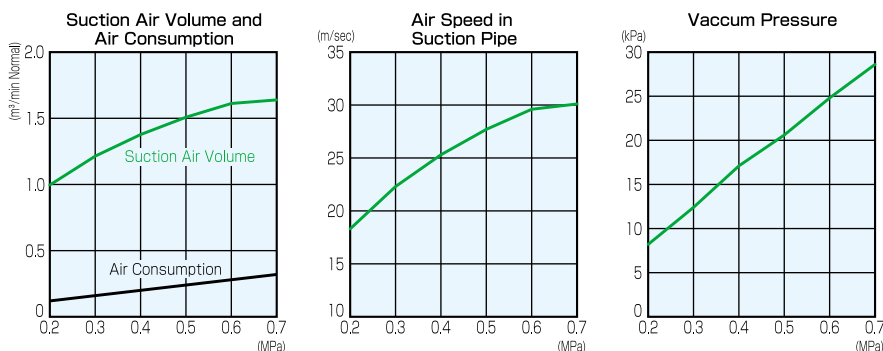

Recommended Compressor Power **2.2kw~3kw**

### Mini Porter Cyclone Serie

- MP-38CF12  
.....Plate Thickness 1.2mm Hose ID $\phi 38$
- MP-50CF12  
.....Plate Thickness 1.2mm Hose ID $\phi 50$
- MP-38WACF12  
.....Plate Thickness 1.2mm Hose ID $\phi 38$
- MP-50WACF12  
.....Plate Thickness 1.2mm Hose ID $\phi 50$

For custom-orders, please contact us.

■ *Manufactured by*



**OSAWA & COMPANY**

1-7-28, Yunagi, Minato-ku, Osaka, 552-0004 Japan  
TEL: +81-6-6572-1207 FAX: +81-6-6572-1256  
<http://www.osawa-company.co.jp>  
E-mail: [osawa@osawa-company.co.jp](mailto:osawa@osawa-company.co.jp)



*Specifications are subject to change without notice.* 2019-01-07-05